

INSTALLATION INSTRUCTION

Integral Perform High Bays

3 Year Warranty

Product Code	Power (W)	Net Weight (Kg)
ILHBC310	100	2.2
ILHBC315	150	2.5
ILHBC320	200	2.8

Eye Ring Dimensions			
Power	Thread	InternalØ	ExternalØ
100W	M10	23.42mm	44.34mm
150W	M10	23.42mm	44.34mm
200W	M10	23.42mm	44.34mm

Technical Characteristics	
Input Voltage	100-277V 50/60Hz
Power Factor	>0.95
Surge Protection	CM 4KV, DM 4KV
IP Rating	IP65
IK Rating	IK08
Op. ambient temp.	< 45°C

Dimensions:

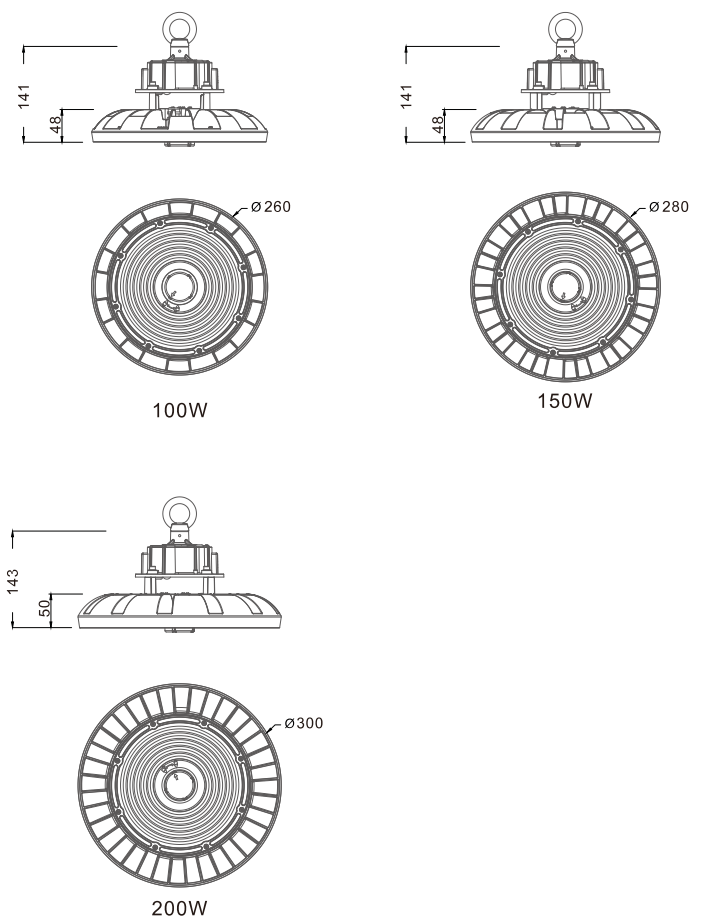

Thank you for purchasing an INTEGRAL LED product. When installed correctly this unit will provide years of service. For support or warranty information please see integral-led.com. Always turn off circuit power at the distribution unit before installation and maintenance. Please ensure that the power cannot be connected inadvertently.

Important Details - Please read prior to installation

1. This product must be installed by a qualified electrician in accordance with instructions provided and in compliance with recognised electrical and safety regulations relevant to the country it is being installed.
2. Do NOT use the luminaire if damaged.
3. Should the unit malfunction, return to distributor or reseller. No user serviceable parts inside. Risk of electric shock, do not disassemble or attempt to repair the luminaire.
4. No fixings screws or chain provided. Ensure you have all tools and accessories needed for suspended mounted installation to support product weight.
5. Consideration should be taken to ensure all fixings are of suitable size for the luminaire to be installed.
6. Ensure mounting eye is securely tightened and fully engaged into the fixing point at the top of the fitting.
7. To avoid damage, DO NOT lift, carry or let the luminaire hang by any part of the wiring.
8. This product is Class I - Earth connection required.
9. Failure to comply with the recommendations and instructions provided herein may cause damage to the luminaire or present a risk of injury or death (e.g. short-circuit, fire, burns or electric shock). Any modifications to the luminaire, incorrect installation or unfit positioning may be dangerous to users and may cause the warranty to become void.
10. The luminaire should be mounted in free air it is recommended not to exceed 45°C ambient. Never cover the luminaire with heat insulation materials. Avoid contact with any corrosive chemicals.
11. The luminaire should be positioned at least 1 metre away from radios, failure to do so may affect radio reception.

Installation nstructions

12. Ensure that the power is OFF during installation and that power cannot be unexpectedly reconnected.
13. This fitting requires suspension via the mounting eye ensuring the front face is in a horizontal position.
14. Use suitable tools and fixings to mount the light fitting safely and securely to the surface. Depending on the substrate, alternative fixings to the item supplied may be required. Avoid damage to any wiring.
15. Use suitable IP rated enclosure or connector to wire the light fixture to mains.
16. Wire the mains adequately to the luminaire supplied cable, H05RN-F 3x1.00mm², Brown (Live), Blue (Neutral) and Yellow/Green (Ground), paying attention to polarity and earth, as shown on figure 1. Cable supplied is 2 meters long.
17. Should you require to connect this luminaire to a 1-10V dimming device please connect the dimming control wires, as shown on figure 2.
18. Check connections and switch power ON when safe to do so.

Figure 1

Brown: Live
Yellow/green: Earth
Blue: Neutral



The Circular high bay is a Class I device - an earth connection is MANDATORY.

Figure 2

Gray (-)
Purple (+)



If the luminaire is not be connected to a dimming system please isolate the dimming wires appropriately.



~100-277 V 50/60 Hz 0-10V

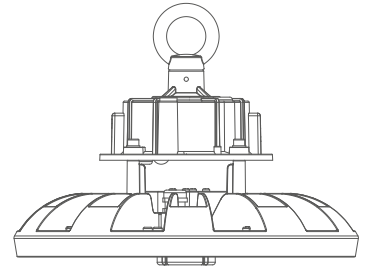
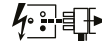

Suspended mounting (a)

1a ⚡ 100-277V + 0-10V

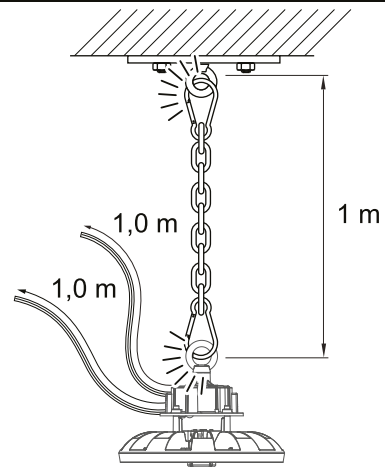
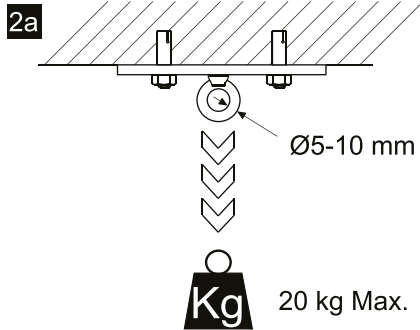
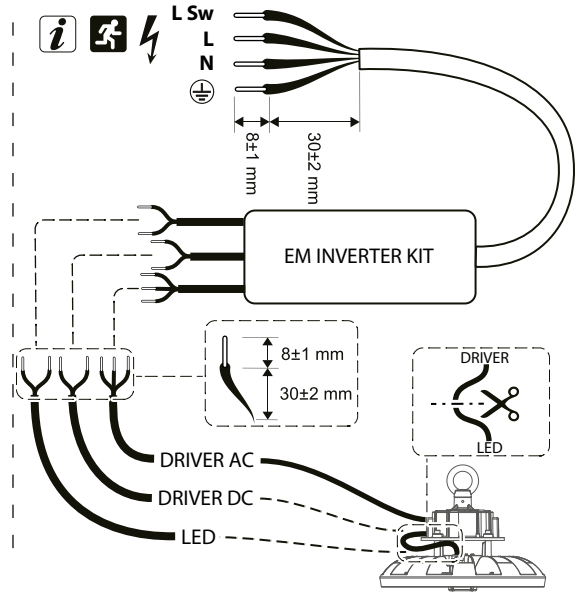
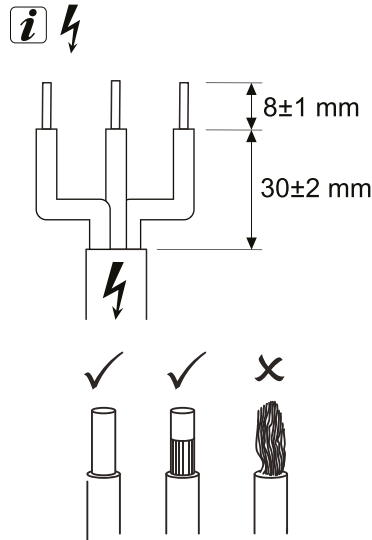
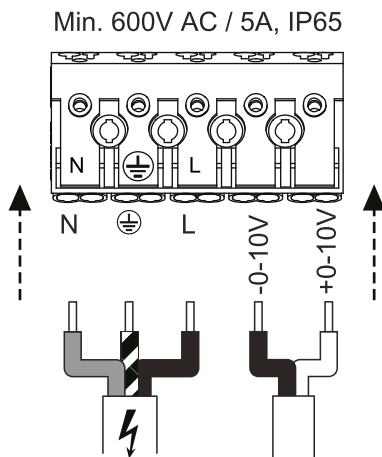

3a Lamp shade - Accessory

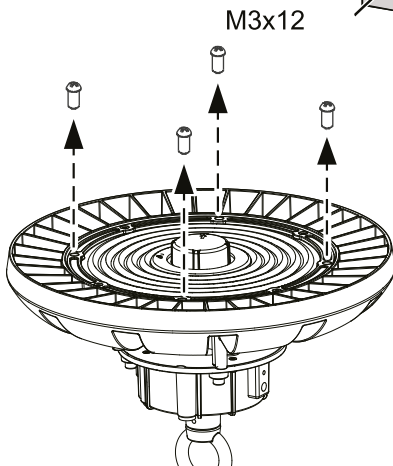

4a

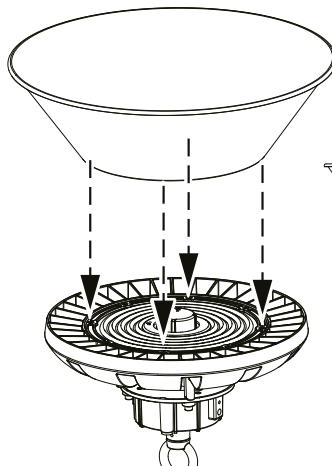

5a

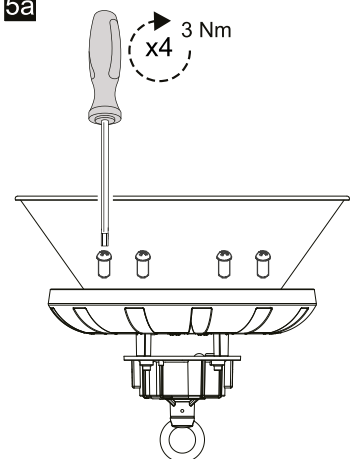

Bracket mounting (b)



2b

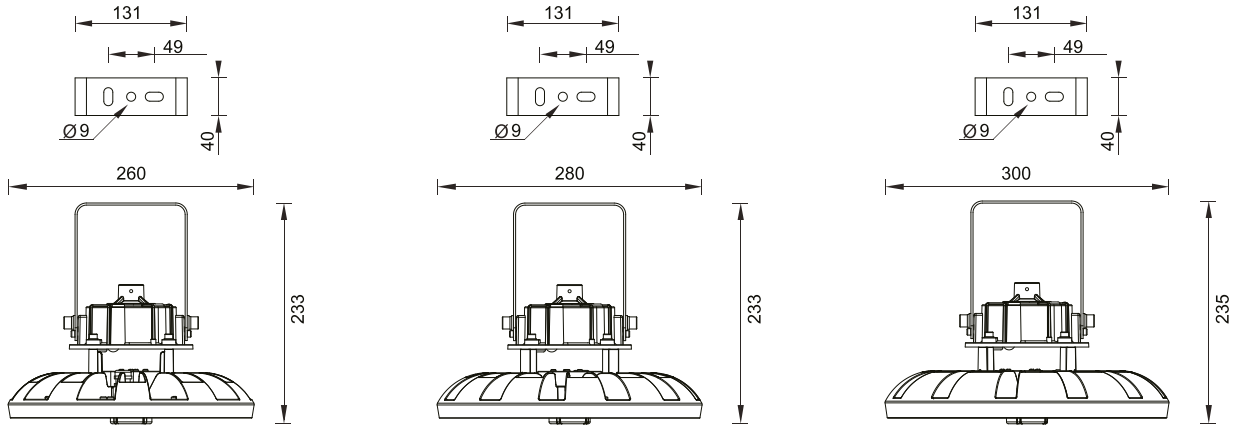

3b

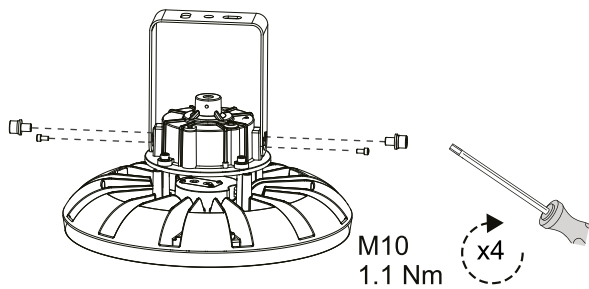

4b

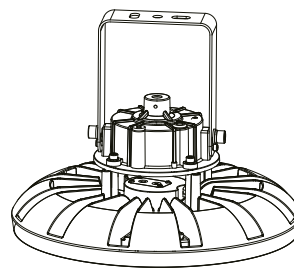

5b Lamp shade - Accessory

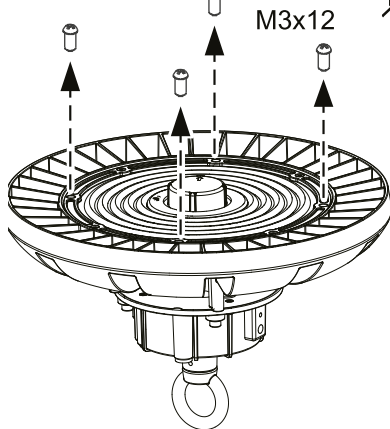

6b

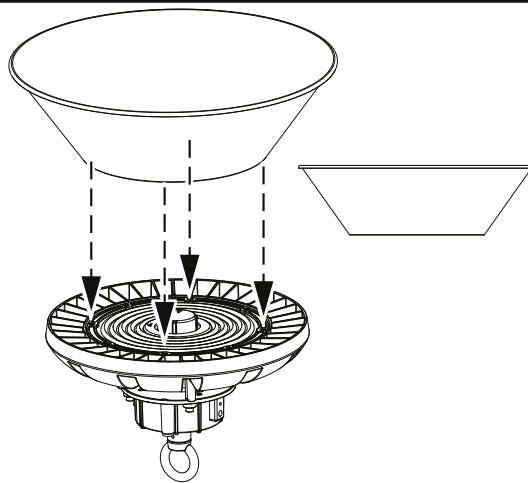

7b

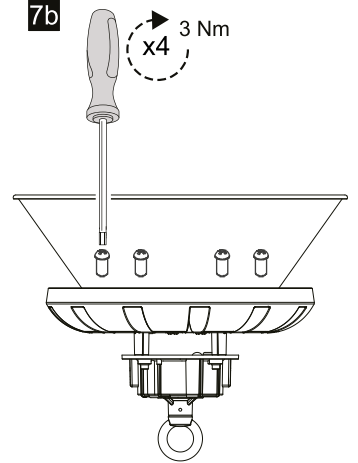

!

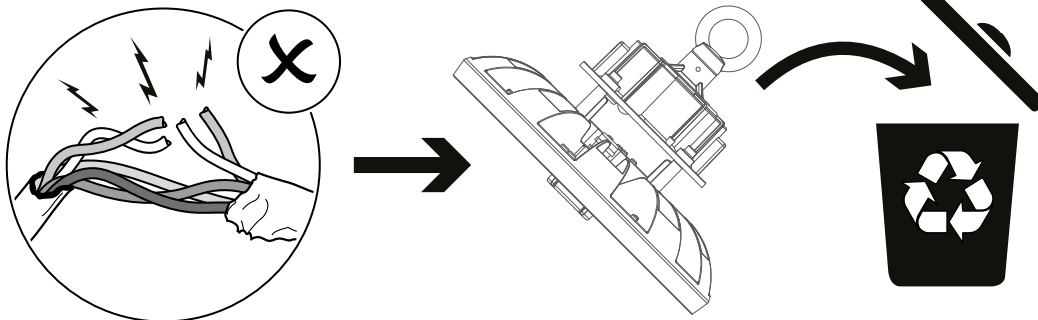

Sensor installation (C)

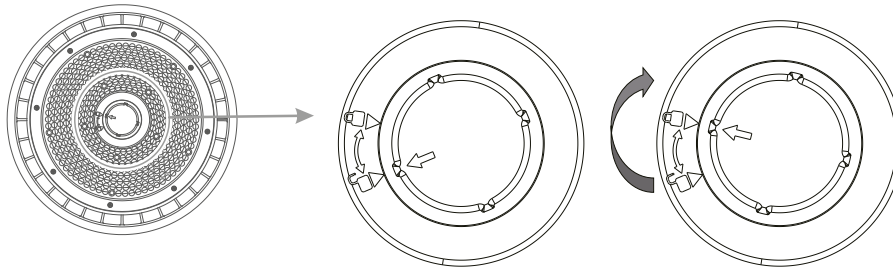

Sensor installation should match triangle logos together on sensor box and lens, press it down and turn to the second triangle with clockwise rotation. Only professionals could open it.

MW remote function (D)

Remote controller HRC-05



HRC-05

Permanent ON/OFF function

Press the “ON/OFF” button, the light goes to permanent on or permanent off mode.
* Press “Auto Mode”, “RESET” or “Scene mode” buttons to quit from this mode.

Sensor mode

Press “Auto Mode” button, the sensor starts to work and all settings remain the same as the last status before the light was switched on/off.

Reset function

Press “RESET” button, all settings go back to the value of DIP switch settings.

Dim +/-

Long press “Dim +” or “Dim -” to adjust the light brightness during hold-time.
“+” means dimming up, “-” means dimming down.

Test mode

The button “Test 2s” is for testing purpose only. The sensor goes to test mode (hold-time is 2s) automatically after commissioning, meanwhile the stand-by period and daylight sensor are disabled.

* This mode can be ended by pressing “reset”, or any button of “scene mode” and “hold time”. The sensor setting is changed accordingly.

Power output

Press these buttons to select full output level. 80% button allows for energy saving and reverse dimming to compensate for LED lumen depreciation over time. Supports fluorescent 10,000 hr initial burn-in.

Remote controller
HRC-05



Lux disable

Press this button to disable the daylight sensor for threshold control. When motion is detected, the fixture will always turn ON, regardless of ambient light level.



Manual override / absence detection

Note: this button is disabled.

Scene mode

There are four scene modes fixed programs built-into the remote control. Select as appropriate. Each scene can be modified using the remote. The sensor will remember updates even after power outage. The green “RESET” button on remote reverts to original defaults.

Scene options	Detection range	Hold-time	Stand-by period	Stand-by dimming level	Daylight sensor
SC1	100%	1min	10min	10%	2Lux
SC2	100%	5min	10min	10%	2Lux
SC3	100%	10min	30min	10%	10Lux
SC4	100%	10min	+∞	10%	50Lux

Note: end-user can adjust the settings by pressing buttons of detection range / hold-time / stand-by period / stand-by dimming level / daylight sensor. The latest setting stays in validity.

Remote controller
HRC-05

Detection range

Select as appropriate to adjust/reduce sensor sensitivity, detection range from 100%. Please refer to detection pattern.

Hold-time

Hold-time refers to the time period that the light remains 100% on if no more movement is detected.

Daylight sensor

Select daylight sensor threshold level at MIN 2 LUX or MAX 50LUX. Ambient light must below this MIN LUX threshold for sensor to turn fixture ON. Press Blue button to sample ambient light. Press Lux Disable button for fixture to always turn On when motion is detected.

Stand-by period (tri-level control)

Press the buttons of “stand-by period” to set stand-by period at 0s / 10s / 1min / 10min / 30min / +∞ .

Note: “0s” means on/off control; “+∞” means bi-level control, light never switches off when daylight sensor is disabled.

Stand-by dimming level

Press the buttons of “stand-by dimming level” to set the stand-by dimming level at 10% / 20% / 30% .