

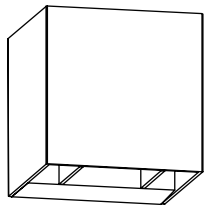

IS 1001

This product contains a lightsource of energy efficiency class <G>.



ILDEA094

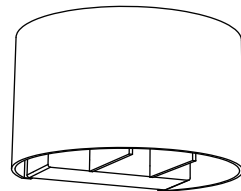

ILDEA095

1 Preparation for Installation / Préparation à l'installation / Voorbereiding voor installatie / Preparación para la instalación / Vorbereitung für die Installation / Przygotowanie do instalacji / Preparação para instalação / Preparazione per l'installazione

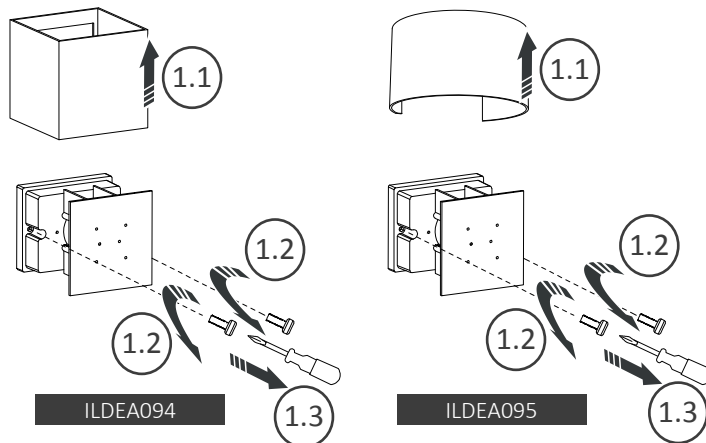

2 Installation / Installation / Installatie / Instalación / Installation / Instalacja / Instalação

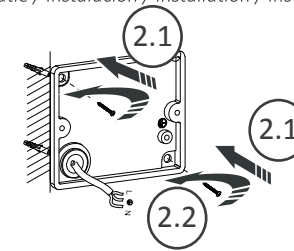

3 Connection / Lien / Verbinding / Conexión / Verbindung / Połączenie / Conexão / Connessione

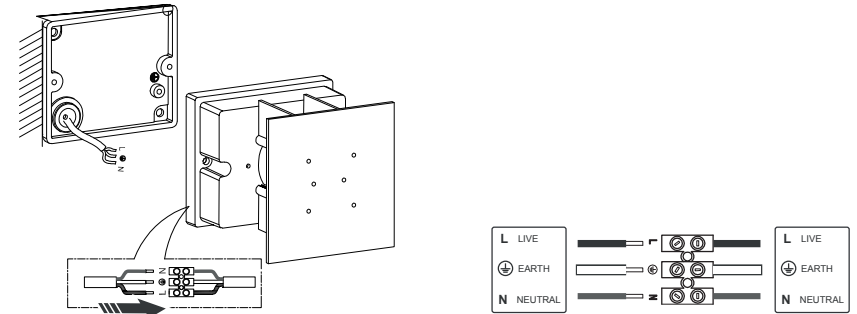

4 Installation / Installation / Installatie / Instalación / Installation / Instalacja / Instalação

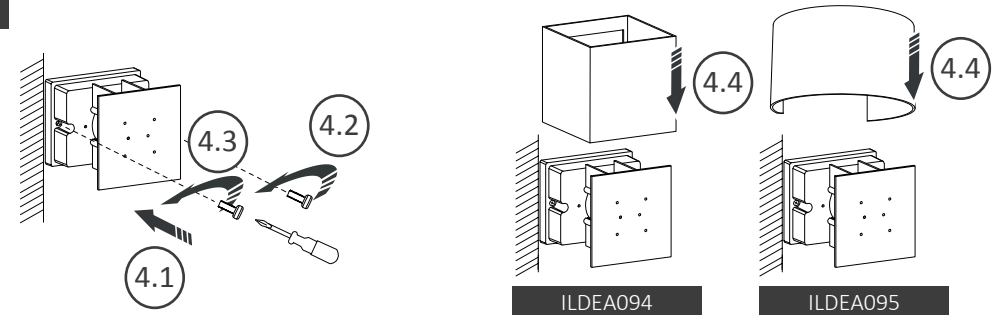

5 Installation / Installation / Installatie / Instalación / Installation / Instalacja / Instalação

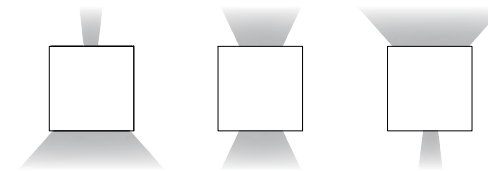

Warranty/ Technical & contact information are all available at www.integral-led.com

ILDEA094 / ILDEA095_V1



All Trademarks Acknowledged

Integral LED is a division of Integral Memory plc:
Unit 6, Iron Bridge Close, Iron Bridge Business Park,
London, NW10 0UF, UK
Integral Europe BV, 2801 DG, NL